



INFLATABLE LIFERAFT

**OPERATION MANUAL
FOR SOLAS LIFERAFTS**

**THROW OVER-BOARD &
DAVIT LAUNCHED
TYPES**

www.lalizas.com

Contents

- 1. Installation**

- 2. Operating Method**
 - 2.1 Inflation of throw over board liferaft**
 - 2.2 Inflation of davit-launched liferaft**

- 3. Boarding**

- 4. Free-floating**

- 5. Self-protection and SOS**

- 6. Maintenance and repair**

This manual applies to OCEANO SOLAS Throw Over-Board & Davit-Launched liferafts for the International voyages manufactured by LALIZAS.

1. Installation

1.1 General method of installation

The liferaft packed in canister is usually located on the cradle alongside the ship board. When installing, the liferaft shall be fixed by special lashing. One end of the lashing is connected to a slide hook, which is connected to hydrostatic release unit fixed to the cradle. Besides, the painter line of the canister shall be fixed firmly to a connecting ring of the hydrostatic release unit. (Picture 1)

There is an easy-broken rope, which is fixed to the clamping plate of the hydrostatic release unit, on this connecting ring. In the normal time, it is prohibited to pull out the painter line from the canister.

1.2 Installation of ship bow's extra liferaft

Usually there is an extra liferaft at the bow of big ships, which shall be fixed to the cradle. Usually hydrostatic release unit is not equipped to this liferaft, instead; there shall be a quick release hook. The liferaft painter line shall be fixed firmly to the cradle.

2. Operating Methods

2.1 Inflation of throw over board liferaft

When it is necessary to use the liferaft, throw it into the water, inflate it fully by following the operating processes below:

2.1.1 Release the slide hook of lashing. Firstly pull out the pin, then push upward the slide ring, the slide hook will then be released from the lashing (Picture 2).

2.1.2 After releasing the lashing, if there is an inclined slideway, the canister will fall into the water due to its own gravity (Picture 3). Otherwise, take the canister out of the cradle and throw it into the water. (Picture 3)

2.1.3 During the time of the canister falling into the water, the painter line will be pulled out continuously. When the canister arrives at the water surface, the pulling out of painter line shall go on immediately, until the release cable connected to the painter line activates the operation head of the CO₂ cylinder (Picture 4). The CO₂ gas will then inflate into the buoyancy tube of the liferaft to make it to be inflated to its full shape and float on the water surface. (Picture 5a)

2.1.4 If the liferaft is in upward-floating position after it is fully inflated, pull the painter line to draw the liferaft to close to the ship.

2.1.5 If the liferaft is in reversed position after it is fully inflated, one person shall right it over to upward-floating position first, then do as per 2.1.4

2.1.6 The operator shall stand on the side which is equipped with CO₂ cylinder, and pull it suddenly to right the liferaft (Picture 6). It will be easier under condition of down wind.

2.2 Inflation of davit-launched liferaft

2.2.1 When a davit-launched liferaft is used as a throw over board liferaft, its inflation method is the same as 2.1. Its usage is the same as 5 & 6.

2.2.2 Usage of davit-launched liferaft

- 2.2.2.1** Gather the davit-launched liferaft alongside the shipboard (Picture 7).
- 2.2.2.2** Move the davit-launched liferaft to the opening of shipboard railing (under the position of the special davit). (Picture 8).
- 2.2.2.3** Tie the bowing line of the canister to the 2 sides of the railing of its opening. Connect the shackle to the quick release hook of the davit. (Picture 9).
- 2.2.2.4** Pull out the painter line to inflate the liferaft at the deck of the shipboard. Tie the boarding step firmly (Picture 10), then the passengers can board into the liferaft.
- 2.2.2.5** Loose the breaking rope of the davit, so that the liferaft can get down to the water surface slowly (Picture 11).
- 2.2.2.6** Separate the davit and the liferaft by pulling the quick release hook of the davit. In the meantime, cut off the painter line, and paddle away the liferaft from the sinking ship (Picture 12).

3. Boarding

3.1 After the liferaft is close to the shipboard, the passengers can board the liferaft through boarding ramp or boarding ladder or other ways. If the passenger's position is not far away from the water surface, he or she can jump into the liferaft directly. The passengers fallen into the water shall swim close to the liferaft, and then board the liferaft through boarding ramp or boarding ladder.

3.2 After all the passengers have boarded the liferafts, separate the liferaft from the shipped quickly by cutting off the painter line. Then paddle away the liferaft from the sinking ship. (Picture 13)

3.3 After boarding, except seating orderly, the occupants shall search the others in the water and help them to board the liferaft. The occupants can throw the rescue quoit with enough length of rope to the persons in the water and pull them to the liferaft side after they grab the rescue quoit, then help them to board into the liferaft. During the night, the occupants can search the sea surface by electric torch and whistle to raise the attention of the persons in the sea.

3.4 When the liferaft is away from the sinking ship and in a safe position, launch the sea anchor to avoid liferaft floating too far away from the sinking ship for the shake of rescuing in time.

4. Free-floating

When the ship is sinking so rapidly that it is impossible to release the liferaft manually, the canister will sink together with the ship. When it sinks to 2-4 meters below the water surface, the lashing of the canister will be released automatically by the hydrostatic release unit due to water pressure, then the canister will float freely on the water. During the continuous sinking of the ship, the painter line will be pulled out continuously with the help of its own buoyancy, until activate the operation head of the cylinder to fully inflate the liferaft. When the ship sinks further, the easy-broken line will break, thus the liferaft will separate from the sinking ship. (Picture 14)

5. Self-protection and SOS

5.1 Inflate the floor by bellow manually if the floor is inflatable, so that the passenger can sit comfortably and keep warm. (Picture 15)

5.2 Close the canopy door in the cold season and during the night to resist cold wind.

5.3 Use bailer and sponge to remove the accumulated water in the liferaft.

5.4 Send various kinds of SOS signals correctly to be found and rescued as early as possible. Including:

5.4.1 Set up the radar reflector as early as possible.

5.4.2 During the night, turn on the indication light on the top of the liferaft. (The battery of the indication light can be used for more than 12 hours.) Search the situation of the sea and the sky through outlook window. If there is a plane or ship passing by, launch the parachute signal or had flare, or send Morse signals by using electric torch. (Picture 16)

5.4.3 During day time, send SOS signal to the passing ships or planes by launching orange smoke signal or using signal mirror. The indication light shall be turned off to save electricity during the day time.

5.4.4 If there is a wireless radio, wireless indication light or radar responder in the liferaft, send SOS signal according to the usage.

5.5 There is emergency pack(s) inside liferaft, which includes various equipments and accessories. Read the "Survival at Sea" carefully to master the correct way of using all kinds of equipments and accessories and the correct processing methods in different emergencies. (Picture 17)

5.6 There are food ration, fresh water and first aid kit inside the liferaft, but in limited quantities, which shall be used restrictively.

5.7 There are rain catchments on the canopy. Remember to collect rain water when raining.

5.8 When the pressure of the buoyancy tube is insufficient, inflate it by the bellow manually.

6. Maintenance and repair

6.1 Pay attention to the maintenance and repairing of the liferaft during the period of floating on the sea to keep it in good condition. Be very careful with the flammable fabric of the liferaft, which is also damageable to the sharp goods.

6.2 If the liferaft body is damaged, repair it immediately. There is repair kit inside the emergency pack of the liferaft, which includes repair tools and materials. Use rubber plug, repair clamp or fabric together with glue to repair according to different situation of damage. (Picture 18)

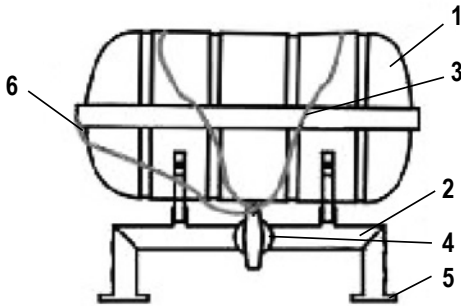

Picture 1
Installation on Board

- 1. Container
- 2. Cradle
- 3. Lashing
- 4. Hydrostatic release unit
- 5. Deck
- 6. Painter line

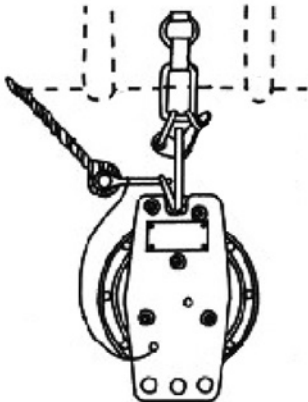

Picture 2
Loose Slip-hook

- 1. Container
- 2. Lashing
- 3. Pin
- 4. Slip-ring
- 5. Slip-hook
- 6. Hydrostatic release unit
- 7. Weak link cord
- 8. Painter

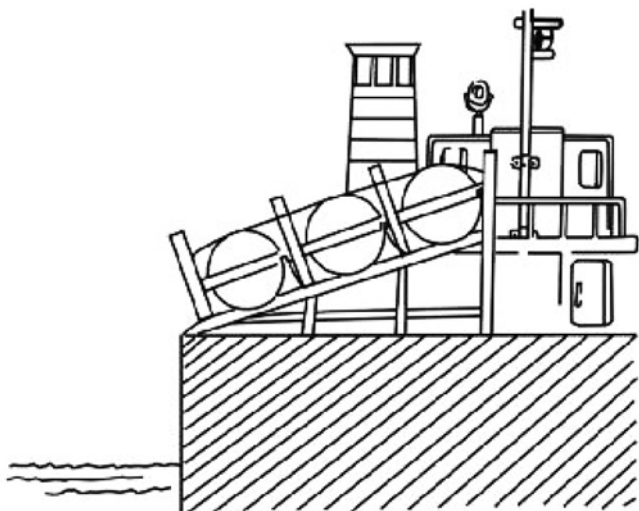

Picture 3
Launching along slider

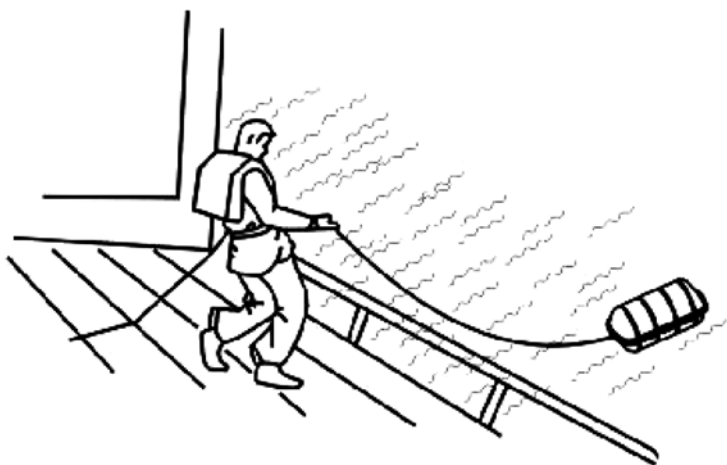

Picture 4
Pulling Out Painter to Let Raft Inflated to Shape

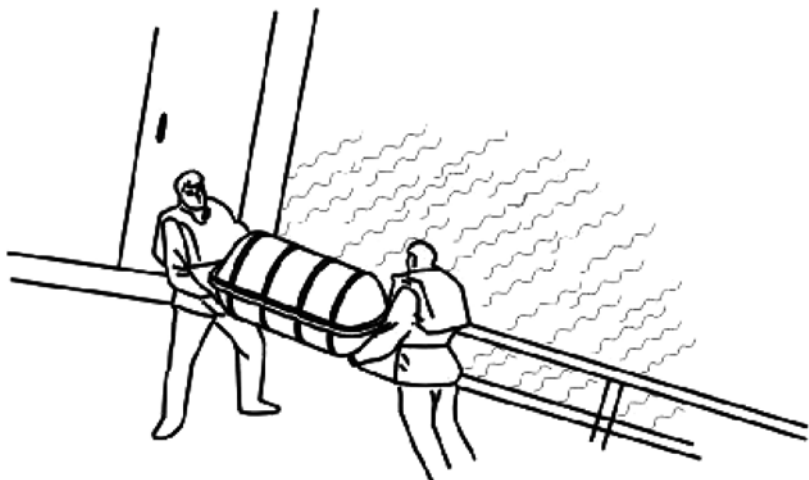

Picture 5
Throwing over Board

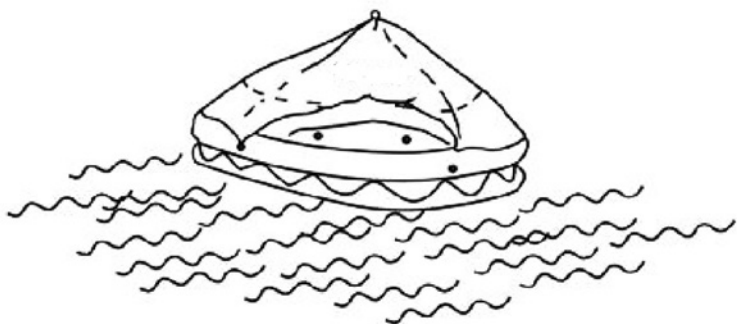

Picture 5a
Inflating Waterborne

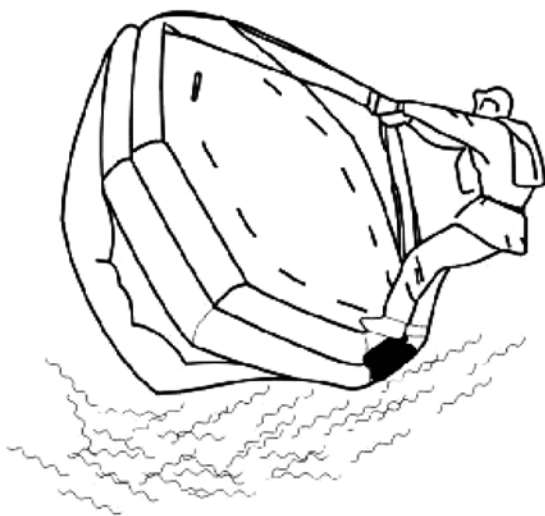

Picture 6
Righting

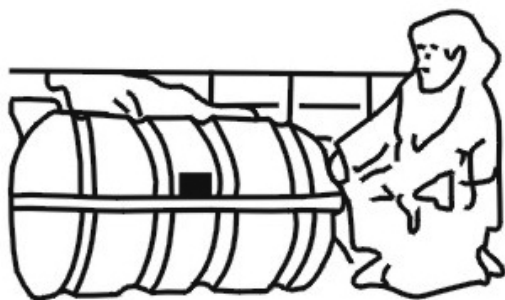

Picture 7
Gathering the Davit-Launched Liferaft

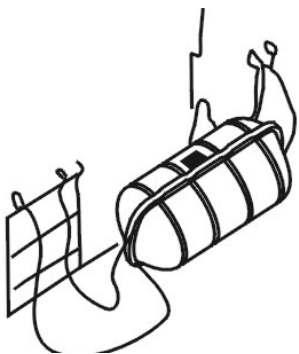

Picture 8

Move the Davit-Launched Liferaft to the opening of the shipboard railing

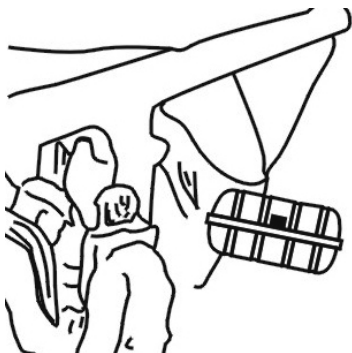

Picture 9

Tie the bowing lines to the opening of the railing. Connect the shackle



Picture 10

Inflate the liferaft.
Boarding.

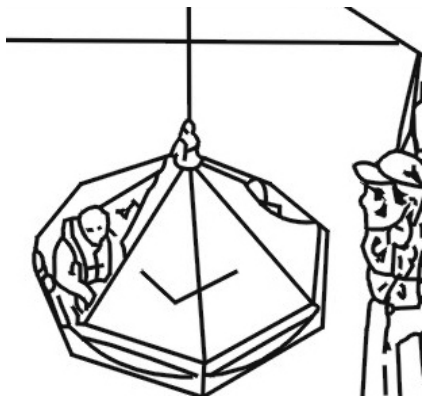

Picture 11
Loose the bowing line
to get down the liferaft



Picture 12
Separate the liferaft
from the davit of the ship



Picture 13
Cut the Painter

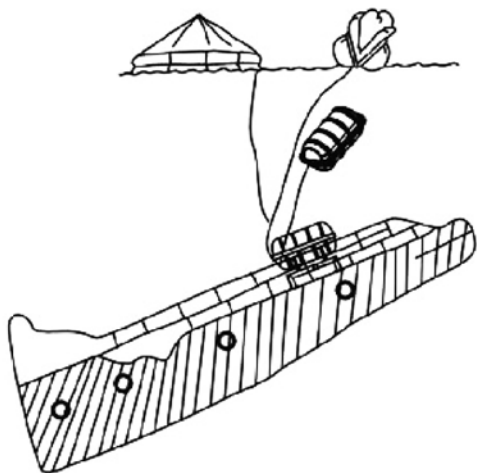

Picture 14
Free floating



Picture 15
Inflate Floor (if inflatable) with
Bellows



Picture 16
Send signals for Help to Ship
And Aircrafts at Night

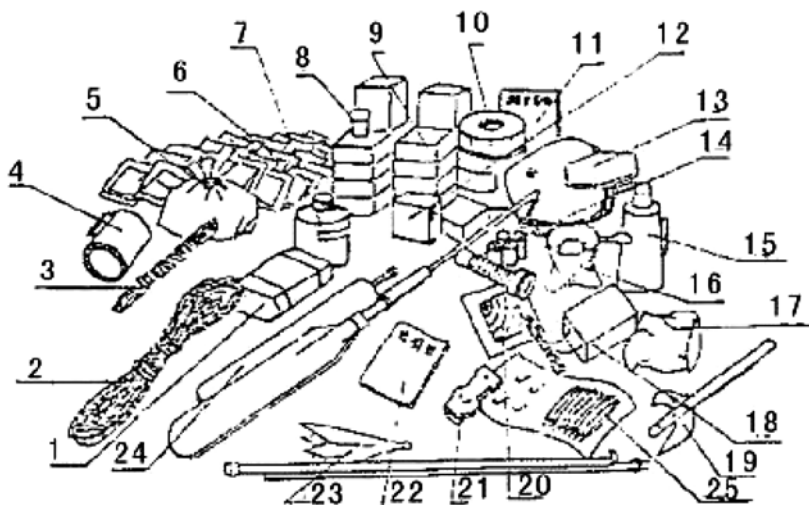

Picture 17 Miscellaneous Appliances Equipped in Liferaft

1. Red flares
2. Rope
3. Sea-anchor and line
4. Floating smoke signal
5. Repair Kit
7. Rocket parachute
8. Drinking cup
9. Rations
10. First-aid kit
11. Lifesaving guide
12. Sponge
13. Bellows
14. Waterproofs torch
15. Thermal protective aid
16. Bailer
17. Sea-sickness bag
18. Battery
19. Tin opener
20. Signaling mirror
21. Whistle
22. Instruction book
23. Radar reflector
24. Paddles
25. Fishing tackle

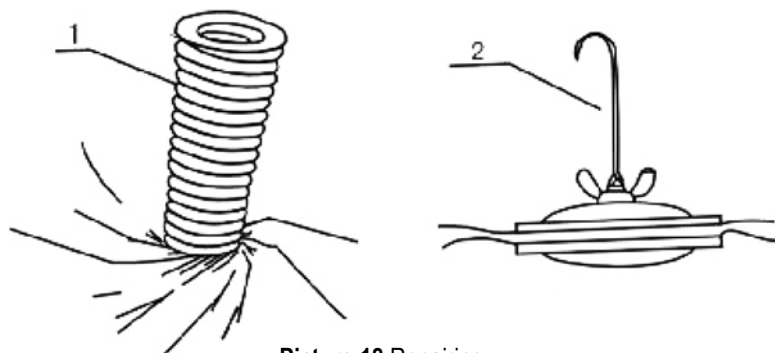

Picture 18 Repairing

1. Conical plug for patching and its use
2. Clamp and use

LALIZAS Hellas

3 Gounari, Piraeus P.C.18531, Greece

Tel.: +30 210 4226274, Fax: +30 210 4226273

e-mail: info@lalizas.com, www.lalizas.com